

MDH*/MDM* series

HYDRAULIC CYLINDER

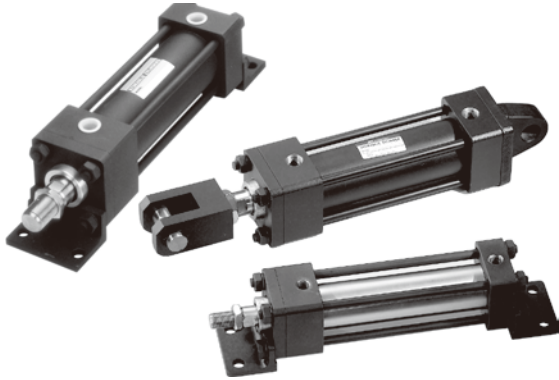

Specification

Model	MDHB, MDHD, MDHN	
Tube I.D. (mm)	40, 50, 63	80, 100, 125, 150
Standard stroke (mm)	50, 100, 150, 200, 250, 300, 350, 400, 450, 500	
The range of stroke	Max.1500 mm	Max.1900 mm
Medium	Filtered oil	
Material of cylinder barrel	Carbon steel STKM 13C	
Max. operating pressure	14 MPa	
Ambient temperature	-10~+60°C (No freezing)	

Model	MDMB, MDMD, MDMN		
Tube I.D. (mm)	40, 50	63	80, 100
Standard stroke (mm)	50, 100, 150, 200, 250, 300, 350, 400, 450, 500		
Medium	Filtered oil		
Material of cylinder barrel	SUS304 Stainless steel		
Max. operating pressure	7 MPa		
Proof pressure	10.5 MPa		
Speed range (mm/sec)	0.5~300 mm/sec		
Ambient temperature	-10~+60°C (No freezing)		
Sensor switch (*)	LN01P	LN02P	LN03P

Double acting

MDHB	Standard type	
MDHD	Double rod type	
MDHN-A/B	Adjustable forward stroke cylinder	

Double acting (with magnet)

MDMB	Standard type	
MDMD	Double rod type	
MDMN-A/B	Adjustable forward stroke cylinder	

* LN**P specification, please refer to page 5-17.

* The series of hydraulic cylinder can be with cushion.

Order example

1 - MDHB - 50 - N - 100 - BC - A - LB - Y

STANDARD **WITH MAGNET**

TUBE I.D.

STROKE

CUSHION
R: Rod end with cushion
H: End end with cushion
B: Both end with cushion
N: No cushion

ADJUSTABLE STROKE
Blank: Standard type
A: Adjustable 25mm
B: Adjustable 50mm
(Only for MD*N type)

PORT & CUSHION ADJ. LOCATION

* Change port & cushion adj. location.
Port location (B) (C) Cushion adjustment location

Blank: Standard type
(A) Port location
(B) Cushion adjustment location

MOUNTING TYPE

	FA
	FB
	LA
	LB
	CA
	CB
	TC
	Y
	I

SEAL MATERIAL

Symbol	Seal material	Kind of fluid				
		Petroleum - based fluid	Water - glycol fluid	Phosphate - ester fluid	Water in oil fluid	Oil in water fluid
1	NBR Nitrile rubber	○	○	×	○	○
2	PU Polyurethane rubber	○	×	×	△	△
3	VITON Fluoro elastomer	○	×	○	○	○

Note. ○ allowable × unallowable △ consult us

MDHB, MDHD, MDHN Standard stroke

Unit: mm

Tube I.D.	50	100	150	200	250	300	350	400	450	500
ø40	●	●	●	●	●	●	—	—	—	—
ø50	●	●	●	●	●	●	—	—	—	—
ø63	●	●	●	●	●	●	●	●	●	●
ø80	●	●	●	●	●	●	●	●	●	●
ø100	●	●	●	●	●	●	●	●	●	●
ø125	●	●	●	●	●	●	●	●	●	●
ø150	●	●	●	●	●	●	●	●	●	●

Note. May to order of unstandard stroke.

MDMB, MDMD, MDMN Standard stroke

Unit: mm

Tube I.D.	50	100	150	200	250	300	350	400	450	500
ø40	●	●	●	●	●	●	—	—	—	—
ø50	●	●	●	●	●	●	—	—	—	—
ø63	●	●	●	●	●	●	●	●	●	●
ø80	●	●	●	●	●	●	●	●	●	●
ø100	●	●	●	●	●	●	●	●	●	●

Note. May to order of unstandard stroke.

Cylinder weight

Unit: kg

Model	Basic weight MDHB	Stroke 25 mm MDHB	Basic weight MDHD	Basic weight MDHN-A	Basic weight MDHN-B	Stroke 25 mm MDHD/MDHN
Tube I.D.						
ø40	3.7	0.155	4.8	5.5	5.8	0.21
ø50	6.2	0.244	8.0	9.1	9.6	0.34
ø63	8.9	0.421	11.2	12.8	13.4	0.60
ø80	14.6	0.546	17.3	19.5	20.3	0.80
ø100	24.2	0.895	28.2	31.3	32.3	1.28
ø125	40.9	1.462	49.4	53.2	54.4	2.01
ø150	64.5	2.337	80.5	87.6	89.4	3.31

Model	Basic weight MDMB	Stroke 25 mm MDMB	Basic weight MDMD	Basic weight MDMN-A	Basic weight MDMN-B	Stroke 25 mm MDMD/MDMN
Tube I.D.						
ø40	3.66	0.14	4.8	5.5	5.8	0.21
ø50	6.15	0.22	8.0	9.1	9.5	0.32
ø63	8.70	0.34	11.0	12.6	13.2	0.53
ø80	14.60	0.54	17.3	19.5	20.3	0.80
ø100	23.80	0.75	27.8	30.9	32.0	1.14

Model	FA	FB	LA	LB	CA	CB+Pin	TC	Y+Pin	I	Nut (Rod)
Tube I.D.										
ø40	0.3	0.6	0.5	0.6	0.6	0.7	0.6	0.6	0.6	0.02
ø50	0.8	1.2	0.9	0.8	1.0	1.1	1.0	0.9	0.9	0.04
ø63	1.3	1.8	1.0	1.4	1.8	2.1	1.2	1.5	1.2	0.08
ø80	1.4	2.7	1.6	1.8	3.0	3.6	2.1	1.8	1.8	0.08
ø100	2.2	4.8	1.9	3.0	5.1	6.6	3.8	4.2	3.3	0.18
ø125	3.6	8.1	3.6	6.0	10.2	12.9	6.2	6.9	6.0	0.22
ø150	6.2	13.5	5.1	8.4	16.2	20.4	10.9	10.8	9.6	0.57

HYDRAULIC CYLINDER

mindman

Stroke tolerance

Unit: mm

stroke	~100	101~250	251~630	631~1000	1001~1600	1601~2000
Tolerance	+0.8	+1.0	+1.25	+1.4	+1.6	+1.8
	0	0	0	0	0	0

MDHB, MDHD, MDHN Theoretic force

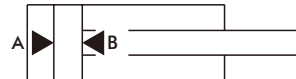

Unit: KN

Tube I.D. (mm)	Rod (mm)	Area (mm ²)	Operating pressure (MPa)									
			6	7	8	9	10	11	12	13	14	
ø40	ø20	A	1256	7.54	8.79	10.05	11.30	12.56	13.82	15.07	16.33	17.58
		B	942	5.65	6.59	7.54	8.48	9.42	10.36	11.30	12.25	13.19
ø50	ø25	A	1963	11.78	13.74	15.70	17.67	19.63	21.59	23.56	25.52	27.48
		B	1472	8.83	10.30	11.78	13.25	14.72	16.19	17.66	19.14	20.61
ø63	ø35	A	3116	18.70	21.81	24.93	28.06	31.18	34.28	37.39	40.51	43.62
		B	2154	12.92	15.08	17.23	19.39	21.54	23.69	25.85	28.00	30.16
ø80	ø40	A	5024	30.14	35.17	40.19	45.22	50.24	55.26	60.29	65.31	70.34
		B	3768	22.61	26.38	30.14	33.91	37.68	41.45	45.22	48.98	52.75
ø100	ø50	A	7850	47.10	54.95	62.80	70.65	78.50	86.35	94.20	102.05	109.90
		B	5887	35.32	41.21	47.10	52.98	58.87	64.76	70.64	76.53	82.42
ø125	ø60	A	12266	73.60	85.86	98.13	110.39	122.66	134.93	147.19	159.46	171.72
		B	9440	56.64	66.08	75.52	84.96	94.40	103.84	113.28	122.72	132.16
ø150	ø80	A	17662	105.97	123.63	141.30	158.96	176.62	194.28	211.94	229.61	247.27
		B	12638	75.83	88.47	101.10	113.74	126.38	139.02	151.66	164.29	176.93

MDMB, MDMD, MDMN Theoretic force

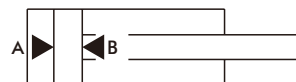

Unit: KN

Tube I.D. (mm)	Rod (mm)	Area (mm ²)	Operating pressure (MPa)									
			2	3	4	5	6	7	8	9	10	
ø40	ø20	A	1256	2512	3768	5024	6280	7536	8792	10048	11304	12560
		B	942	1884	2826	3768	4710	5652	6594	7536	8478	9420
ø50	ø25	A	1963	3926	5889	7852	9815	11778	13741	15704	17667	19630
		B	1472	2944	4416	5888	7360	8832	10304	11776	13248	14720
ø63	ø35	A	3116	6232	9348	12464	15580	18696	21812	24928	28062	31180
		B	2154	4308	6462	8616	10770	12924	15078	17232	19386	21540
ø80	ø40	A	5024	10048	15072	20096	25120	30144	35168	40192	45216	50240
		B	3768	7536	11304	15072	18840	22608	26376	30144	33912	37680
ø100	ø50	A	7850	15700	23550	31400	39250	47100	54950	62800	70650	78500
		B	5887	11774	17661	23548	29435	35322	41209	47196	52983	58870

The method of calculation (Hydraulic cylinders' force)

$$F = P \times A - f$$

F :	Cylinders' force	(N)
P :	Operating pressure	(MPa)
A :	Piston area	(mm ²)
f :	Friction drag	(N)

How to order the seal kit

MDHBSK

Tube I.D.	Seal kit
40	MDHBSK40 - Including No.13,14,15,16,17,18
50	MDHBSK50 - Including No.13,14,15,16,17,18
63	MDHBSK63 - Including No.13,14,15,16,17,18
80	MDHBSK80 - Including No.13,14,15,16,17,18
100	MDHBSK100 - Including No.13,14,15,16,17,18
125	MDHBSK125 - Including No.13,14,15,16,17,18
150	MDHBSK150 - Including No.13,14,15,16,17,18

MDHDSK

Tube I.D.	Seal kit
40	MDHDSK40 - Including No.10,11,12,13,14,15
50	MDHDSK50 - Including No.10,11,12,13,14,15
63	MDHDSK63 - Including No.10,11,12,13,14,15
80	MDHDSK80 - Including No.10,11,12,13,14,15
100	MDHDSK100 - Including No.10,11,12,13,14,15
125	MDHDSK125 - Including No.10,11,12,13,14,15
150	MDHDSK150 - Including No.10,11,12,13,14,15

MDHB

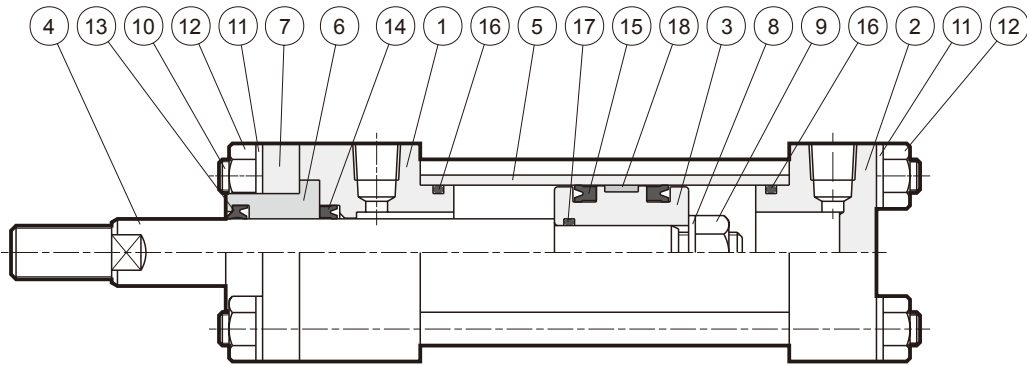

Parts list

No.	Part name	Q'y	No.	Part name	Q'y	No.	Part name	Q'y
1	Rod cover	1	7	End plate	1	13	Dust wiper	1
2	Head cover	1	8	Spring washer	1	14	Rod packing	1
3	Piston	1	9	Piston nut	1	15	Piston packing	2
4	Piston rod	1	10	Tie bolt	4	16	Cylinder gasket	2
5	Cylinder tube	1	11	Spring washer	8	17	Piston gasket	1
6	Rod bush	1	12	Nut	8	18	Wearing ring	1

MDHD

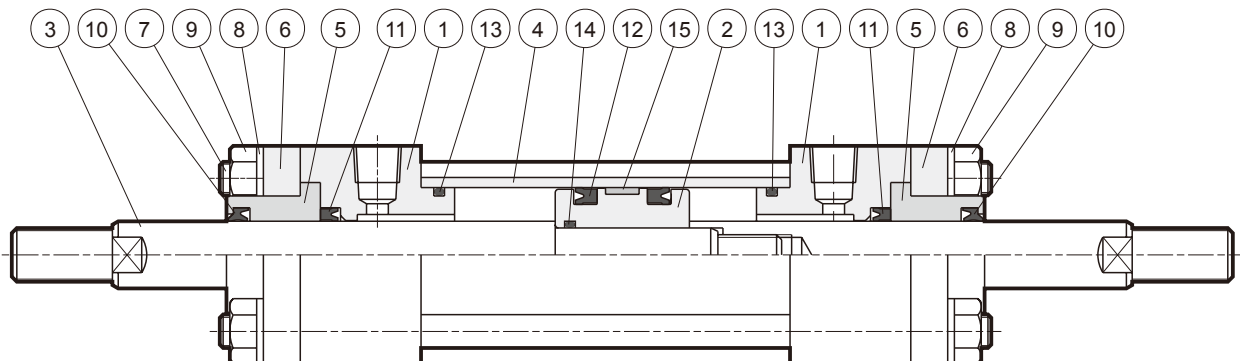

Parts list

No.	Part name	Q'y	No.	Part name	Q'y	No.	Part name	Q'y
1	Rod cover	2	6	End plate	2	11	Rod packing	2
2	Piston	1	7	Tie bolt	4	12	Piston packing	2
3	Piston rod	1	8	Spring washer	8	13	Cylinder gasket	2
4	Cylinder tube	1	9	Nut	8	14	Piston gasket	1
5	Rod bush	2	10	Dust wiper	2	15	Wearing ring	1

HYDRAULIC CYLINDER

How to order the seal kit

MDMBSK

Tube I.D.	Seal kit
40	MDMBSK40 - Including No.13,14,15,16,17
50	MDMBSK50 - Including No.13,14,15,16,17
63	MDMBSK63 - Including No.13,14,15,16,17
80	MDMBSK80 - Including No.13,14,15,16,17
100	MDMBSK100 - Including No.13,14,15,16,17

MDMDSK

Tube I.D.	Seal kit
40	MDMDSK40 - Including No.10,11,12,13,14
50	MDMDSK50 - Including No.10,11,12,13,14
63	MDMDSK63 - Including No.10,11,12,13,14
80	MDMDSK80 - Including No.10,11,12,13,14
100	MDMDSK100 - Including No.10,11,12,13,14

MDMB

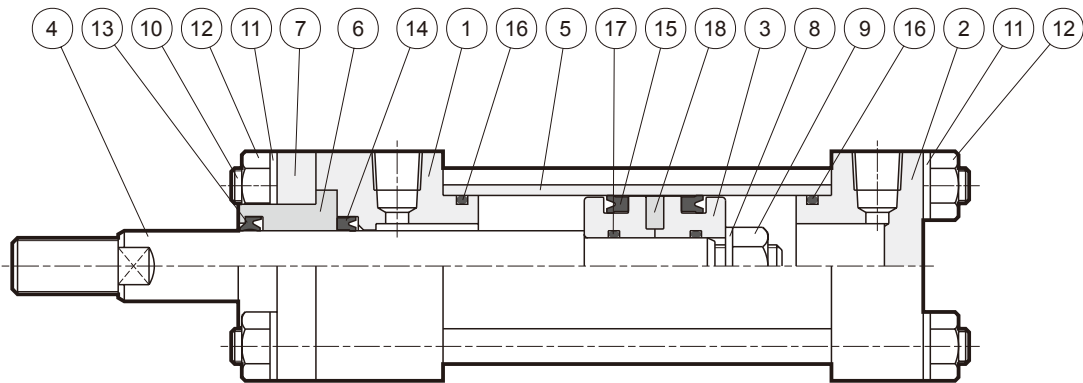

Parts list

No.	Part name	Q'y	No.	Part name	Q'y	No.	Part name	Q'y
1	Rod cover	1	7	End plate	1	13	Dust wiper	1
2	Head cover	1	8	Spring washer	1	14	Rod packing	1
3	Piston	1	9	Nut	1	15	Piston packing	2
4	Piston rod	1	10	Tie bolt	4	16	Cylinder gasket	2
5	Cylinder tube	1	11	Spring washer	8	17	Piston gasket	1
6	Rod bush	1	12	Nut	8	18	Magnet	1

MDMD

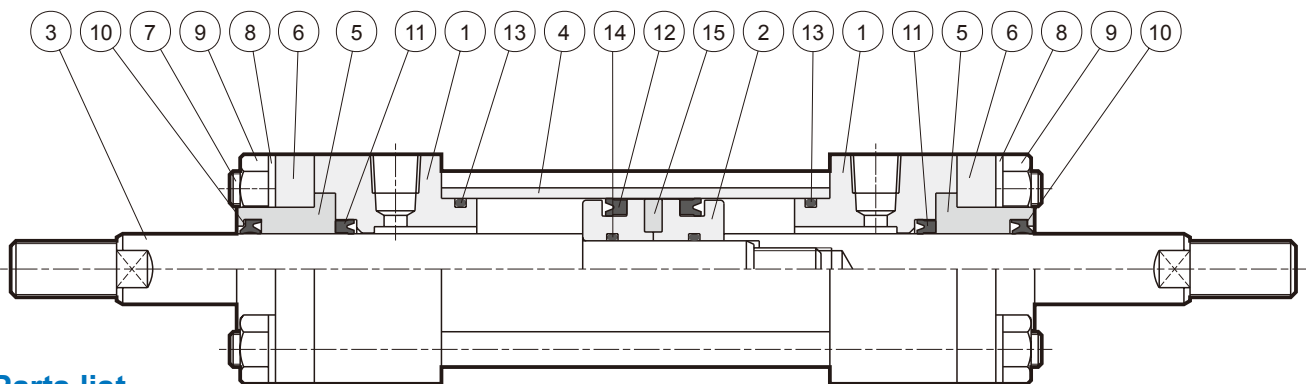

Parts list

No.	Part name	Q'y	No.	Part name	Q'y	No.	Part name	Q'y
1	Rod cover	2	6	End plate	2	11	Rod packing	2
2	Piston	1	7	Tie bolt	4	12	Piston packing	2
3	Piston rod	1	8	Spring washer	8	13	Cylinder gasket	2
4	Cylinder tube	1	9	Nut	8	14	Piston gasket	1
5	Rod bush	2	10	Dust wiper	2	15	Magnet	1

MDHB / MDMB Standard type

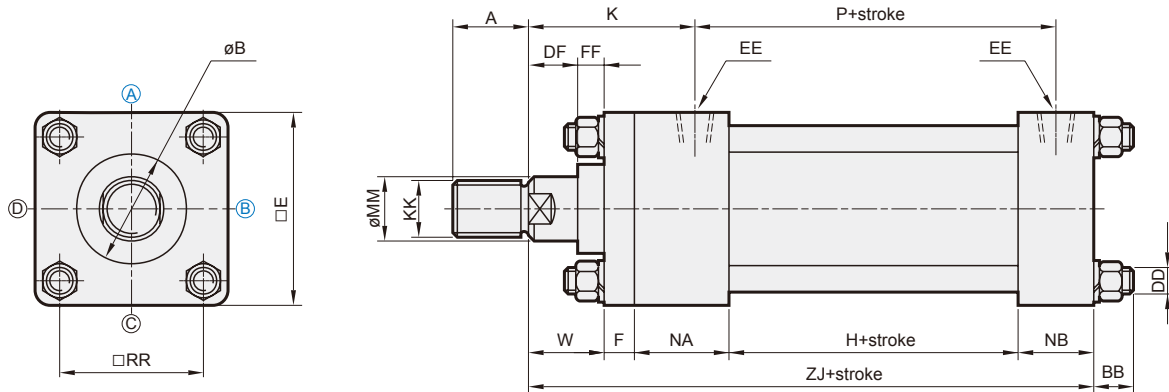

Note. (A) Port location
(B) Cushion adjustment location

Code Tube I.D.	A	B	BB	DD	DF	E	EE	F	FF	H	K	KK	MM	NA	NB	P	RR	W	ZJ
$\varnothing 40$	30	35	16	M10 \times 1.25	14	65	Rc1/4	11	11	60	60	M16 \times 1.5	20	36	26	84	45	25	158
$\varnothing 50$	35	40	16	M10 \times 1.25	16	75	Rc3/8	13	9	60	66	M22 \times 1.5	25	42	34	88	52	25	174
$\varnothing 63$	40	50	18	M12 \times 1.5	21	90	Rc3/8	15	9	65	73	M30 \times 1.5	35	42	34	93	63	30	186
$\varnothing 80$	45	55	18	M16 \times 1.5	23	110	Rc1/2	18	7	65	79	M30 \times 1.5	40	46	39	95	80	30	198
$\varnothing 100$	50	65	25	M18 \times 1.5	33	135	Rc1/2	20	7	74	95	M40 \times 2.0	50	50	40	104	102	40	224
$\varnothing 125$	60	75	30	M22 \times 1.5	38	165	Rc3/4	25	7	74	109	M48 \times 2.0	60	58	47	112	122	45	249
$\varnothing 150$	70	95	30	M26 \times 1.5	43	195	Rc3/4	30	7	90	119	M72 \times 2.0	80	58	48	128	148	50	276

MDHD / MDMD Double rod type

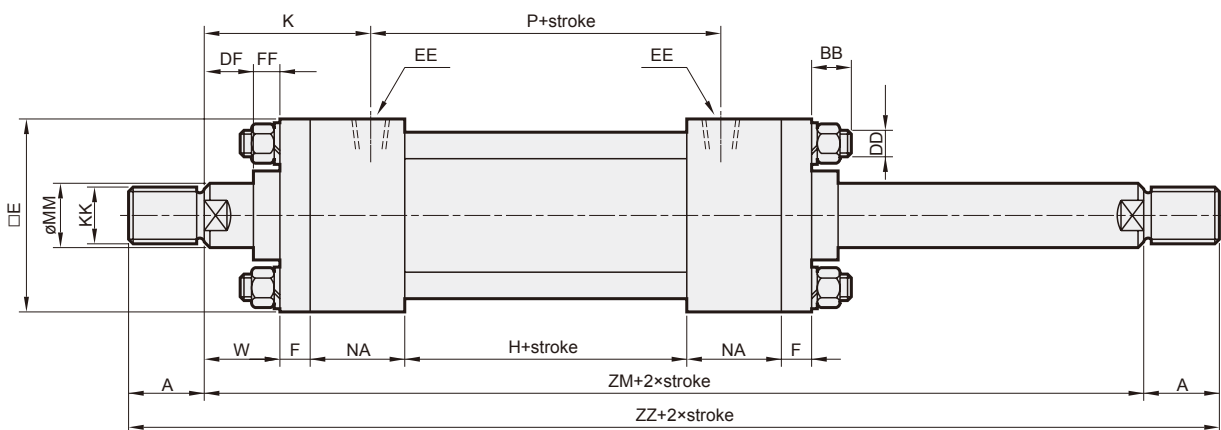

Code Tube I.D.	A	B	BB	DD	DF	E	EE	F	FF	H	K	KK	MM	NA	P	RR	W	ZM	ZZ
$\varnothing 40$	30	35	16	M10 \times 1.25	14	65	Rc1/4	11	11	60	60	M16 \times 1.5	20	36	84	45	25	204	264
$\varnothing 50$	35	40	16	M10 \times 1.25	16	75	Rc3/8	13	9	60	66	M22 \times 1.5	25	42	88	52	25	220	290
$\varnothing 63$	40	50	18	M12 \times 1.5	21	90	Rc3/8	15	9	65	73	M30 \times 1.5	35	42	93	63	30	239	319
$\varnothing 80$	45	55	18	M16 \times 1.5	23	110	Rc1/2	18	7	65	79	M30 \times 1.5	40	46	95	80	30	253	343
$\varnothing 100$	50	65	25	M18 \times 1.5	33	135	Rc1/2	20	7	74	95	M40 \times 2.0	50	50	104	102	40	294	394
$\varnothing 125$	60	75	30	M22 \times 1.5	38	165	Rc3/4	25	7	74	109	M48 \times 2.0	60	58	112	122	45	330	450
$\varnothing 150$	70	95	30	M26 \times 1.5	43	195	Rc3/4	30	7	90	119	M72 \times 2.0	80	58	128	148	50	366	506

FA Front flange

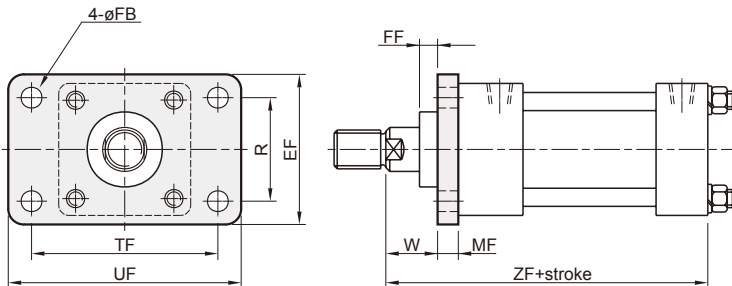

Code Tube I.D.	EF	FB	FF	MF	R	TF	UF	W	ZF
$\varnothing 40$	69	11	11	11	46	95	118	25	158
$\varnothing 50$	85	11	9	13	58	115	145	25	174
$\varnothing 63$	98	14	9	15	65	132	165	30	186
$\varnothing 80$	118	18	7	18	87	155	190	30	198
$\varnothing 100$	150	22	7	20	109	190	230	40	224
$\varnothing 125$	175	24	7	25	130	224	272	45	249
$\varnothing 150$	210	28	7	30	155	270	320	50	276

FB Rear flange

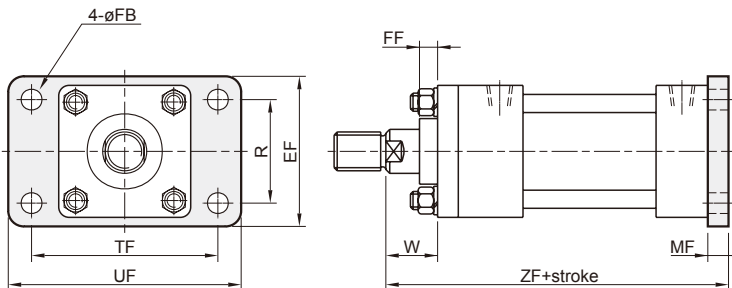

Code Tube I.D.	EF	FB	FF	MF	R	TF	UF	W	ZF
$\varnothing 40$	69	11	11	11	46	95	118	25	169
$\varnothing 50$	85	11	9	13	58	115	145	25	187
$\varnothing 63$	98	14	9	15	65	132	165	30	201
$\varnothing 80$	118	18	7	18	87	155	190	30	216
$\varnothing 100$	150	22	7	20	109	190	230	40	244
$\varnothing 125$	175	24	7	25	130	224	272	45	274
$\varnothing 150$	210	28	7	30	155	270	320	50	306

CA Male pivot

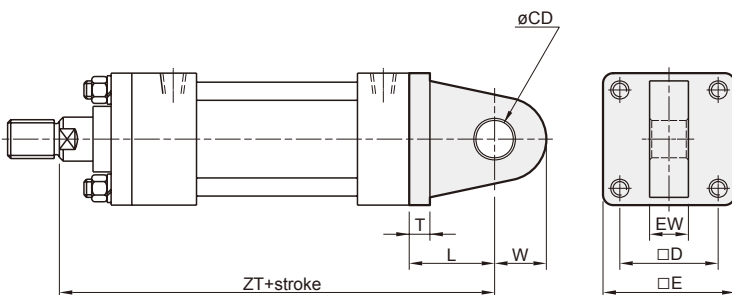

Code Tube I.D.	CD	D	E	EW	L	T	W	ZT
$\varnothing 40$	16	45	65	20	38	11	16	196
$\varnothing 50$	20	52	75	25	45	13	20	219
$\varnothing 63$	25	63	90	30	54	15	25	240
$\varnothing 80$	30	80	110	35	71	18	30	269
$\varnothing 100$	40	102	135	40	86	20	40	310
$\varnothing 125$	50	122	165	50	110	25	50	359
$\varnothing 150$	60	148	195	60	109	30	60	385

CB Female pivot

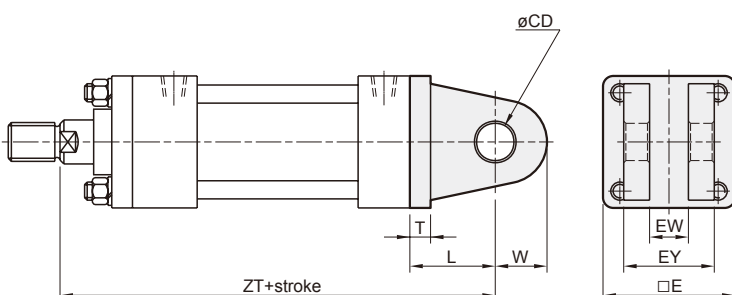

Code Tube I.D.	CD	E	EW	EY	L	T	W	ZT
$\varnothing 40$	16	65	20	50	38	11	16	196
$\varnothing 50$	20	75	25	57	45	13	20	219
$\varnothing 63$	25	90	30	70	54	15	25	240
$\varnothing 80$	30	110	35	80	71	18	30	269
$\varnothing 100$	40	135	40	100	86	20	40	310
$\varnothing 125$	50	165	50	126	110	25	50	359
$\varnothing 150$	60	195	60	160	109	30	60	385

LA Side lugs

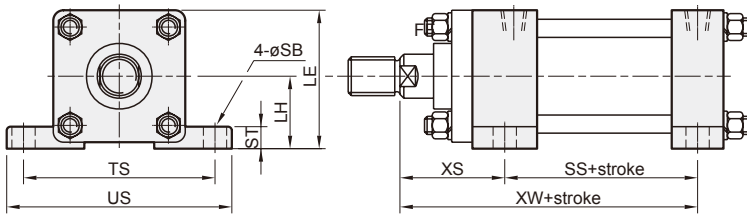

Code Tube I.D.	LE	LH	SB	SS	ST	TS	XS	XW	US
$\varnothing 40$	70	37.5	11	91	14	95	54	145	118
$\varnothing 50$	82.5	45	11	98	17	115	59	157	145
$\varnothing 63$	95	50	14	103	19	132	66	169	165
$\varnothing 80$	115	60	18	107.5	25	155	71	178.5	190
$\varnothing 100$	138.5	71	22	119	27	190	85	204	230
$\varnothing 125$	167.5	85	24	126.5	32	224	99	225.5	272
$\varnothing 150$	203.5	106	28	143	37	270	109	252	320

LB Foot mouting

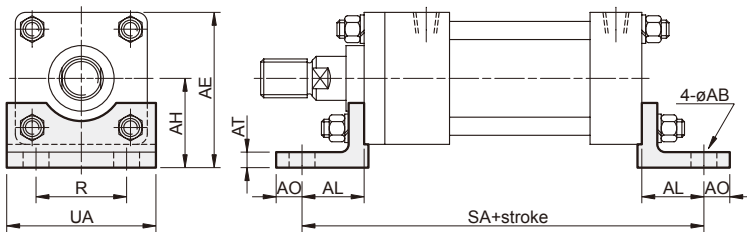

Code Tube I.D.	AB	AE	AH	AL	AO	AT	R	SA	UA
$\varnothing 40$	11	75.5	43	32.5	13	8	46	198	69
$\varnothing 50$	11	87.5	50	32.5	15	8	58	214	85
$\varnothing 63$	14	105	60	37	18	10	65	230	98
$\varnothing 80$	18	127	72	49	20	12	87	266	118
$\varnothing 100$	22	152.5	85	58	23	12	109	300	150
$\varnothing 125$	24	187.5	105	68.5	29	15	130	341	175
$\varnothing 150$	28	220.5	123	74.5	30	18	155	375	210

TC Intermediate pivot

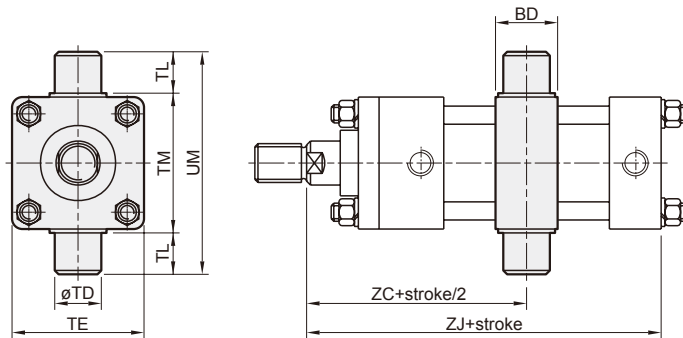

Code Tube I.D.	BD	TE	TD	TL	TM	UM	ZC	ZJ
$\varnothing 40$	28	65	20	20	69	109	102	158
$\varnothing 50$	33	75	25	25	85	135	110	174
$\varnothing 63$	38	90	30	30	98	158	119.5	186
$\varnothing 80$	38	110	30	30	118	178	126.5	198
$\varnothing 100$	48	135	40	40	145	225	147	224
$\varnothing 125$	58	165	50	50	175	275	165	249
$\varnothing 150$	73	195	60	63	205	331	183	276

Installation of sensor switches

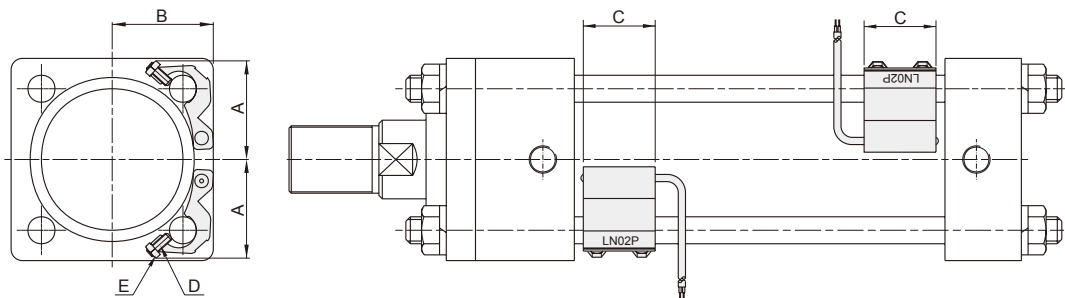

Code Tube I.D.	Sensor switch	A	B	C	D	E
$\varnothing 40$	LN01P	33.7	33	32	M4×12L	M4
$\varnothing 50$	LN01P	36.6	37	32	M4×12L	M4
$\varnothing 63$	LN02P	44	45	32	M4×12L	M4
$\varnothing 80$	LN03P	54	56	32	M4×12L	M4
$\varnothing 100$	LN03P	65	67	32	M4×12L	M4

FA Front flange

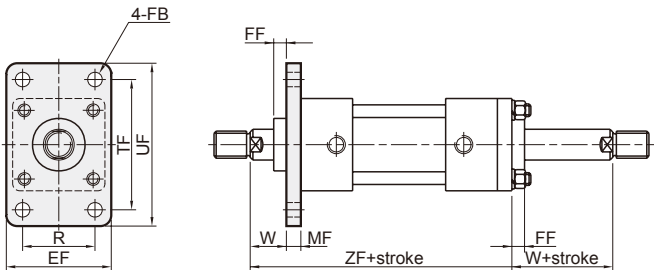

Code Tube I.D.	EF	FB	FF	MF	R	TF	UF	W	ZF
$\varnothing 40$	69	11	11	11	46	95	118	25	179
$\varnothing 50$	85	11	9	13	58	115	145	25	195
$\varnothing 63$	98	14	9	15	65	132	165	30	209
$\varnothing 80$	118	18	7	18	87	155	190	30	223
$\varnothing 100$	150	22	7	20	109	190	230	40	254
$\varnothing 125$	175	24	7	25	130	224	272	45	285
$\varnothing 150$	210	28	7	30	155	270	320	50	316

LA Side lugs

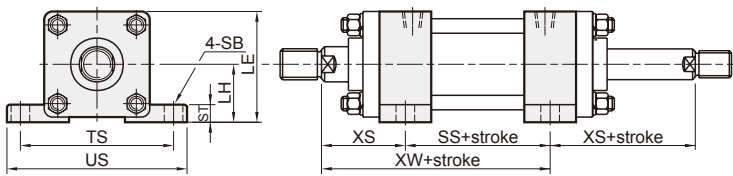

Code Tube I.D.	LE	LH	SB	SS	ST	TS	XS	XW	US
$\varnothing 40$	70	37.5	11	96	14	95	54	150	118
$\varnothing 50$	82.5	45	11	102	17	115	59	161	145
$\varnothing 63$	95	50	14	107	19	132	66	173	165
$\varnothing 80$	115	60	18	111	25	155	71	182	190
$\varnothing 100$	138.5	71	22	124	27	190	85	209	230
$\varnothing 125$	167.5	85	24	132	32	224	99	231	272
$\varnothing 150$	203.5	106	28	148	37	270	109	257	320

LB Foot mounting

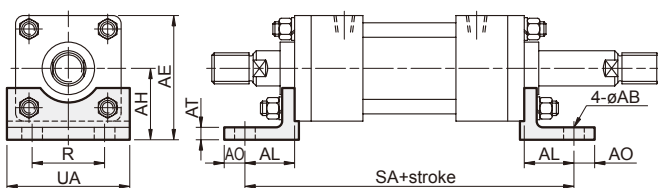

Code Tube I.D.	AB	AE	AH	AL	AO	AT	R	SA	UA
$\varnothing 40$	11	75.5	43	32.5	13	8	46	219	69
$\varnothing 50$	11	87.5	50	32.5	15	8	58	235	85
$\varnothing 63$	14	105	60	37	18	10	65	253	98
$\varnothing 80$	18	127	72	49	20	12	87	291	118
$\varnothing 100$	22	152.5	85	58	23	12	109	330	150
$\varnothing 125$	24	187.5	105	68.5	29	15	130	377	175
$\varnothing 150$	28	220.5	123	74.5	30	18	155	415	210

TC Intermediate pivot

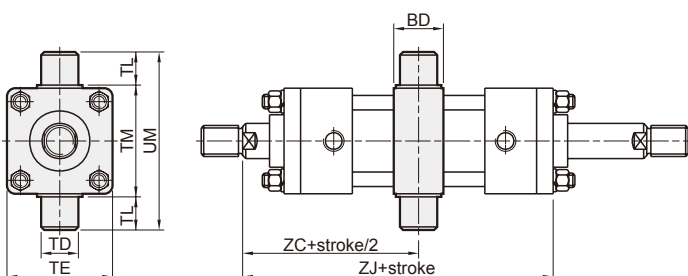

Code Tube I.D.	BD	TE	TD	TL	TM	UM	ZC	ZJ
$\varnothing 40$	28	65	20	20	69	109	102	179
$\varnothing 50$	33	75	25	25	85	135	110	195
$\varnothing 63$	38	90	30	30	98	158	119.5	209
$\varnothing 80$	38	110	30	30	118	178	126.5	223
$\varnothing 100$	48	135	40	40	145	225	147	254
$\varnothing 125$	58	165	50	50	175	275	165	285
$\varnothing 150$	73	195	60	63	205	331	183	316

MDHN/MDMN Adjustable stroke $\varnothing 40\sim\varnothing 150$



HYDRAULIC CYLINDER

mindman

MDHN / MDMN (A : adjustable stroke 25 mm)

Note. (A) Port location
(B) Cushion adjustment location

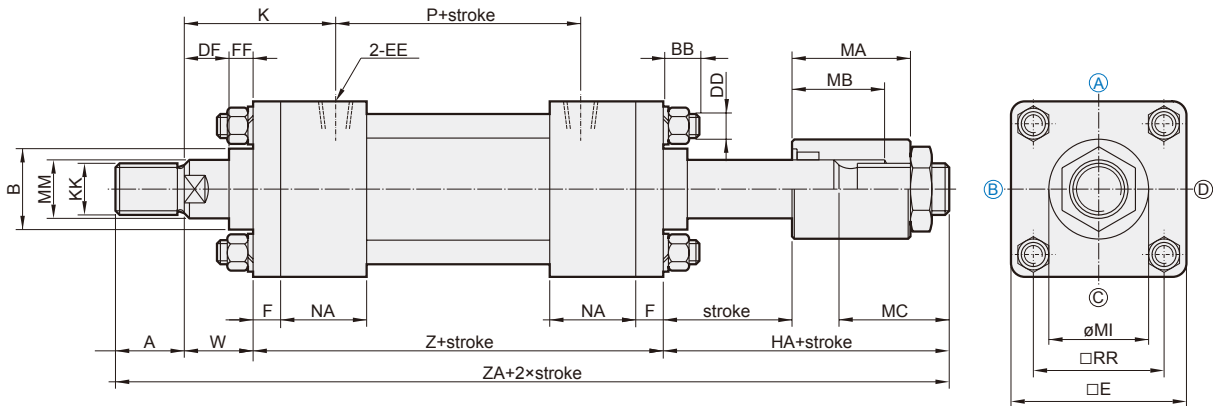

Code Tube I.D.	A	B	BB	DD	DF	E	EE	F	FF	HA	K	KK	MA	MB	MC	MI	MM	NA	P	RR	W	Z	ZA
$\varnothing 40$	30	35	14	M10 \times 1.25	14	65	Rc1/4	11	11	71	59	M16 \times 1.5	60	45	51	42	20	36	86	45	25	154	280
$\varnothing 50$	35	40	14	M10 \times 1.25	16	75	Rc3/8	13	9	77	65	M22 \times 1.5	63	45	57	50	25	42	90	52	25	170	307
$\varnothing 63$	40	50	16	M12 \times 1.5	21	90	Rc3/8	15	9	81	72	M30 \times 1.5	65	45	61	60	35	42	95	63	30	179	330
$\varnothing 80$	45	55	19	M16 \times 1.5	23	110	Rc1/2	18	7	81	76	M30 \times 1.5	65	45	61	70	40	46	101	80	30	193	349
$\varnothing 100$	50	65	25	M18 \times 1.5	33	135	Rc1/2	20	7	88	92	M40 \times 2.0	70	45	68	80	50	50	110	102	40	214	392
$\varnothing 125$	60	75	30	M22 \times 1.5	38	165	Rc3/4	25	7	97	108	M48 \times 2.0	76	46	73	85	60	58	114	122	45	240	442
$\varnothing 150$	70	95	30	M26 \times 1.5	43	195	Rc3/4	30	7	112	118	M72 \times 2.0	86	46	92	110	80	58	130	148	50	266	498

MDHN / MDMN (B : adjustable stroke 50 mm)

Note. (A) Port location
(B) Cushion adjustment location

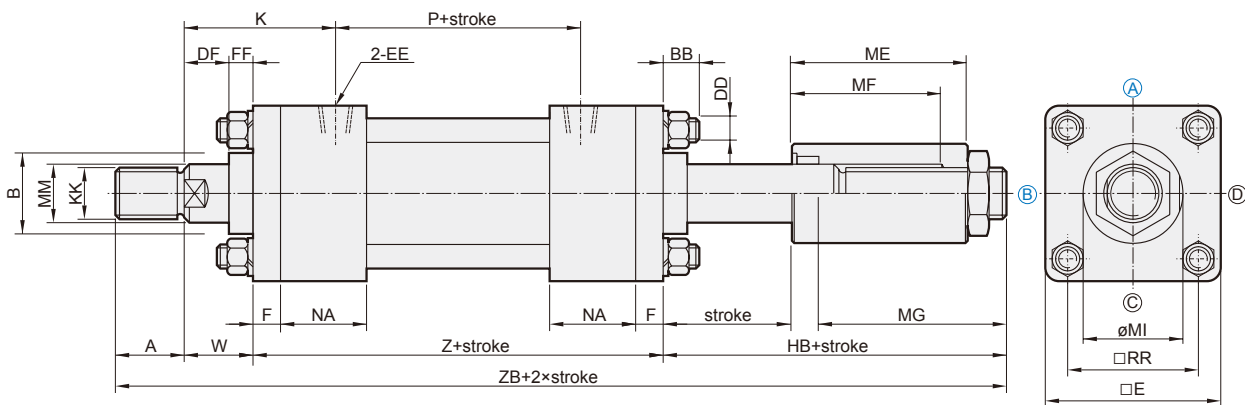

Code Tube I.D.	A	B	BB	DD	DF	E	EE	F	FF	HB	K	KK	ME	MF	MG	MI	MM	NA	P	RR	W	Z	ZB
$\varnothing 40$	30	35	14	M10 \times 1.25	14	65	Rc1/4	11	11	96	59	M16 \times 1.5	85	70	76	42	20	36	86	45	25	154	305
$\varnothing 50$	35	40	14	M10 \times 1.25	16	75	Rc3/8	13	9	102	65	M22 \times 1.5	88	70	82	50	25	42	90	52	25	170	332
$\varnothing 63$	40	50	16	M12 \times 1.5	21	90	Rc3/8	15	9	106	72	M30 \times 1.5	90	70	86	60	35	42	95	63	30	179	355
$\varnothing 80$	45	55	19	M16 \times 1.5	23	110	Rc1/2	18	7	106	76	M30 \times 1.5	90	70	86	70	40	46	101	80	30	193	374
$\varnothing 100$	50	65	25	M18 \times 1.5	33	135	Rc1/2	20	7	113	92	M40 \times 2.0	95	70	93	80	50	50	110	102	40	214	417
$\varnothing 125$	60	75	30	M22 \times 1.5	38	165	Rc3/4	25	7	122	108	M48 \times 2.0	101	71	98	85	60	58	114	122	45	240	467
$\varnothing 150$	70	95	30	M26 \times 1.5	43	195	Rc3/4	30	7	137	118	M72 \times 2.0	111	71	117	110	80	58	130	148	50	266	523

FA (A : adjustable stroke 25 mm)

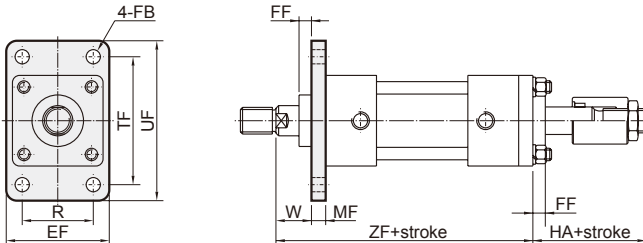

Code Tube I.D.	EF	FB	FF	HA	MF	R	TF	UF	W	ZF
$\varnothing 40$	69	11	11	71	11	46	95	118	25	179
$\varnothing 50$	85	11	9	77	13	58	115	145	25	195
$\varnothing 63$	98	14	9	81	15	65	132	165	30	209
$\varnothing 80$	118	18	7	81	18	87	155	190	30	223
$\varnothing 100$	150	22	7	88	20	109	190	230	40	254
$\varnothing 125$	175	24	7	97	25	130	224	272	45	285
$\varnothing 150$	210	28	7	112	30	155	270	320	50	316

LA (A : adjustable stroke 25 mm)

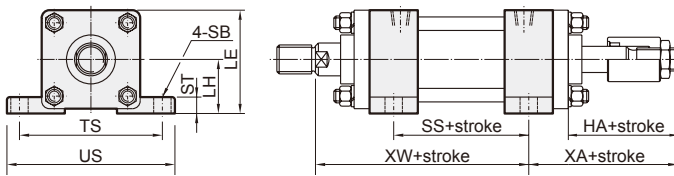

Code Tube I.D.	LE	LH	HA	SB	SS	ST	TS	XA	XW	US
$\varnothing 40$	70	37.5	71	11	96	14	95	100	150	118
$\varnothing 50$	82.5	45	77	11	102	17	115	111	161	145
$\varnothing 63$	95	50	81	14	107	19	132	117	173	165
$\varnothing 80$	115	60	81	18	111	25	155	122	182	190
$\varnothing 100$	138.5	71	88	22	124	27	190	133	209	230
$\varnothing 125$	167.5	85	97	24	132	32	224	151	231	272
$\varnothing 150$	203.5	106	112	28	148	37	270	171	257	320

LB (A : adjustable stroke 25 mm)

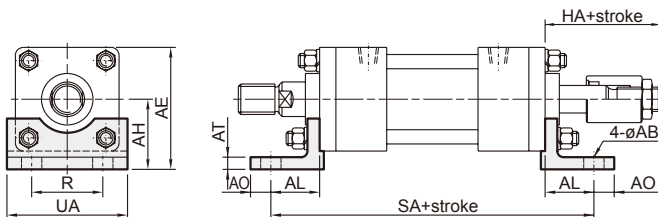

Code Tube I.D.	AB	AE	AH	AL	AO	AT	HA	R	SA	UA
$\varnothing 40$	11	75.5	43	32.5	13	8	71	46	219	69
$\varnothing 50$	11	87.5	50	32.5	15	8	77	58	235	85
$\varnothing 63$	14	105	60	37	18	10	81	65	253	98
$\varnothing 80$	18	127	72	49	20	12	81	87	291	118
$\varnothing 100$	22	152.5	85	58	23	12	88	109	330	150
$\varnothing 125$	24	187.5	105	68.5	29	15	97	130	377	175
$\varnothing 150$	28	220.5	123	74.5	30	18	112	155	415	210

TC (A : adjustable stroke 25 mm)

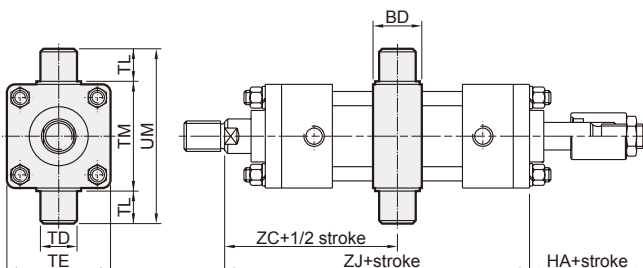

Code Tube I.D.	BD	HA	TE	TD	TL	TM	UM	ZC	ZJ
$\varnothing 40$	28	71	65	20	20	69	109	102	179
$\varnothing 50$	33	77	75	25	25	85	135	110	195
$\varnothing 63$	38	81	90	30	30	98	158	119.5	209
$\varnothing 80$	38	81	110	30	30	118	178	126.5	223
$\varnothing 100$	48	88	135	40	40	145	225	147	254
$\varnothing 125$	58	97	165	50	50	175	275	165	285
$\varnothing 150$	73	112	195	60	63	205	331	183	316

FA (B : adjustable stroke 50 mm)

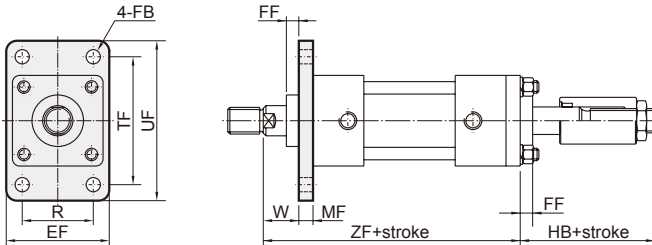

Code Tube I.D.	EF	FB	FF	HB	MF	R	TF	UF	W	ZF
$\varnothing 40$	69	11	11	96	11	46	95	118	25	179
$\varnothing 50$	85	11	9	102	13	58	115	145	25	195
$\varnothing 63$	98	14	9	106	15	65	132	165	30	209
$\varnothing 80$	118	18	7	106	18	87	155	190	30	223
$\varnothing 100$	150	22	7	113	20	109	190	230	40	254
$\varnothing 125$	175	24	7	122	25	130	224	272	45	285
$\varnothing 150$	210	28	7	137	30	155	270	320	50	316

LA (B : adjustable stroke 50 mm)

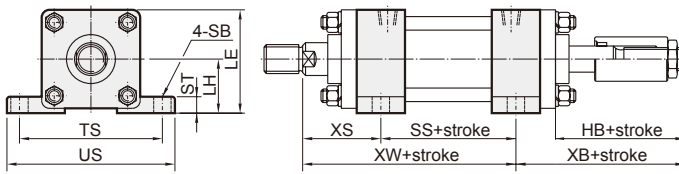

Code Tube I.D.	LE	LH	HB	SB	SS	ST	TS	XB	XW	US
$\varnothing 40$	70	37.5	96	11	96	14	95	125	150	118
$\varnothing 50$	82.5	45	102	11	102	17	115	136	161	145
$\varnothing 63$	95	50	106	14	107	19	132	142	173	165
$\varnothing 80$	115	60	106	18	111	25	155	147	182	190
$\varnothing 100$	138.5	71	113	22	124	27	190	158	209	230
$\varnothing 125$	167.5	85	122	24	132	32	224	176	231	272
$\varnothing 150$	203.5	106	137	28	148	37	270	196	257	320

LB (B : adjustable stroke 50 mm)

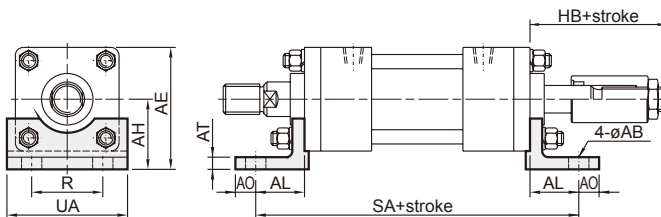

Code Tube I.D.	AB	AE	AH	AL	AO	AT	HB	R	SA	UA
$\varnothing 40$	11	75.5	43	32.5	13	8	96	46	219	69
$\varnothing 50$	11	87.5	50	32.5	15	8	102	58	235	85
$\varnothing 63$	14	105	60	37	18	10	106	65	253	98
$\varnothing 80$	18	127	72	49	20	12	106	87	291	118
$\varnothing 100$	22	152.5	85	58	23	12	113	109	330	150
$\varnothing 125$	24	187.5	105	68.5	29	15	122	130	377	175
$\varnothing 150$	28	220.5	123	74.5	30	18	137	155	415	210

TC (B : adjustable stroke 50 mm)

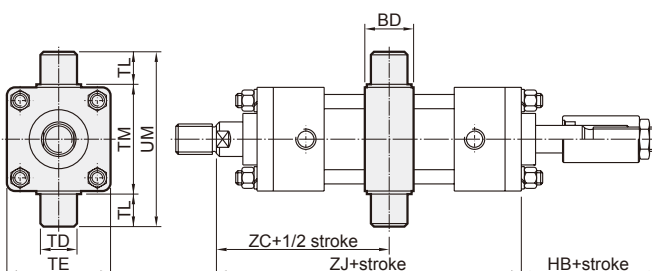

Code Tube I.D.	BD	HB	TE	TD	TL	TM	UM	ZC	ZJ
$\varnothing 40$	28	96	65	20	20	69	109	102	179
$\varnothing 50$	33	102	75	25	25	85	135	110	195
$\varnothing 63$	38	106	90	30	30	98	158	119.5	209
$\varnothing 80$	38	106	110	30	30	118	178	126.5	223
$\varnothing 100$	48	113	135	40	40	145	225	147	254
$\varnothing 125$	58	122	165	50	50	175	275	165	285
$\varnothing 150$	73	137	195	60	63	205	331	183	316

HYDRAULIC CYLINDER

Y connector

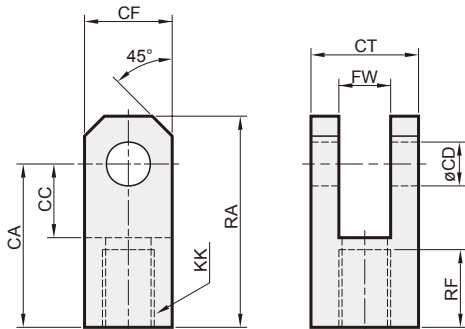

Model	Tube I.D.	CA	CC	CD	CF	CT	FW	KK	RA	RF
Y-M16×1.5	$\phi 40$	50	26	16	35	45	20	M16×1.5	66	24
Y-M22×1.5	$\phi 50$	60	30	20	40	50	25	M22×1.5	80	30
Y-M30×1.5	$\phi 63$	80	40	25	50	60	30	M30×1.5	105	40
Y-M30×1.5	$\phi 80$	80	40	30	60	65	35	M30×1.5	110	40
Y-M40×2.0	$\phi 100$	90	50	40	80	90	40	M40×2.0	130	40
Y-M48×2.0	$\phi 125$	110	60	50	100	100	50	M48×2.0	160	50
Y-M72×2.0	$\phi 150$	130	70	60	120	120	60	M72×2.0	190	60

Pin

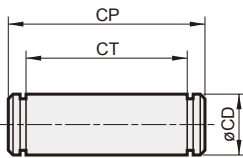

Model	Tube I.D.	CD	CP	CT
P1659	$\phi 40$	16	59	46
P2066	$\phi 50$	20	66	51
P2576	$\phi 63$	25	76	61
P3081	$\phi 80$	30	81	66
P40114	$\phi 100$	40	114	91
P50124	$\phi 125$	50	124	101
P60156	$\phi 150$	60	156	121

I connector

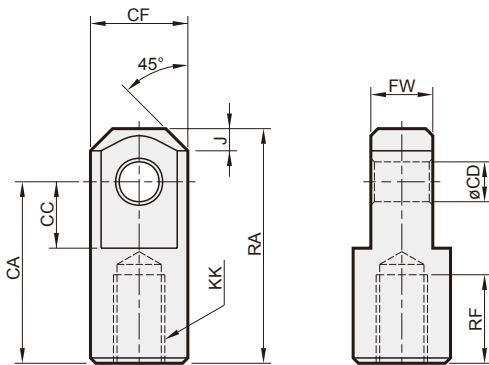

Model	Tube I.D.	CA	CC	CD	CF	FW	J	KK	RA	RF
I-M16×1.5	$\phi 40$	55	30	16	40	20	8	M16×1.5	75	20
I-M22×1.5	$\phi 50$	65	35	20	50	25	10	M22×1.5	90	25
I-M30×1.5	$\phi 63$	80	40	25	55	30	12.5	M30×1.5	110	35
I-M30×1.5	$\phi 80$	90	45	30	60	35	15	M30×1.5	125	35
I-M40×2.0	$\phi 100$	105	55	40	80	40	20	M40×2.0	145	40
I-M48×2.0	$\phi 125$	120	65	50	100	50	30	M48×2.0	170	50
I-M72×2.0	$\phi 150$	140	75	60	120	60	30	M72×2.0	200	55

Mounting nut

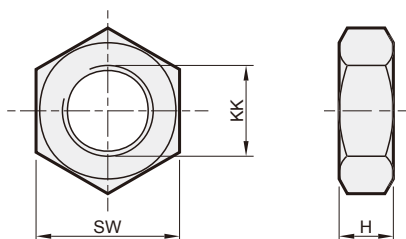

Model	Tube I.D.	H	KK	SW
N-M16×1.5	$\phi 40$	8	M16×1.5	24
N-M22×1.5	$\phi 50$	11	M22×1.5	32
N-M30×1.5	$\phi 63$	13	M30×1.5	41
N-M30×1.5	$\phi 80$	13	M30×1.5	41
N-M40×2.0	$\phi 100$	15	M40×2.0	57
N-M48×2.0	$\phi 125$	15	M48×2.0	65
N-M72×2.0	$\phi 150$	20	M72×2.0	100